

GV6-100 series

100W Waterproof Constant Voltage LED Driver

Features:

- European AC input voltage: 176-264VAC
- Constant voltage design
- Built-in active PFC function (PF > 0.97)
- Protections: Short Circuit / Over Current / Over Temperature / Input Under Voltage
- Cooling by free air convection
- Surge immunity: Differential Mode - 6kV, Common Mode - 10kV
- IP67 design for indoor and outdoor applications
- Suitable for dry/damp/wet locations

Application:

- Landscape Lighting



 **IP67 PFC SELV**

DESCRIPTION

The GV6-100 series is constant voltage led driver, designed for lighting used for landscape illumination. The driver has built-in active PFC, multiple protections, and 10KV surge immunity. It's an excellent design with high reliability and long lifetime.

MODEL INFORMATION

MODEL NUMBER	OUTPUT POWER [W]	OUTPUT VOLTAGE [VDC]	OUTPUT CURRENT RANGE [A]	TYPICAL EFFICIENCY	TYPICAL PF	TYPICAL THD
GV6-100B012	100	12	0 ÷ 8.34	89%	0.97	10%
GV6-100B024	100	24	0 ÷ 4.20	89%	0.97	10%
GV6-100B036	100	36	0 ÷ 2.80	90%	0.97	10%

Notes:

1. All performance parameters are measured at 25°C ambient temperature, 230VAC input, full load conditions if no specific note.

INPUT SPECIFICATIONS

Parameter	Min.	Typ.	Max.	Notes					
INPUT VOLTAGE	176VAC	200 ÷ 240VAC	264VAC	-					
INPUT FREQUENCY	47Hz	50/60Hz	63Hz	-					
LEAKAGE CURRENT	-	-	0.7mA	240VAC/60Hz					
INPUT AC CURRENT	-	-	0.8A	220-240VAC, full load					
INRUSH CURRENT	-	-	75A	230VAC, full load, Cold start					
POWER FACTOR	0.96	0.98	-	230VAC, 50-60Hz, full load					
	0.95	0.97	-	230VAC, 50-60Hz, 75% load					
	0.90	0.95	-	230VAC, 50-60Hz, 50% load					
THD	-	10%	10%	220-240VAC, 50-60Hz, 50-100% load					
MAX. NO. OF PSU ON CIRCUIT BREAKER	B10	C10	B16	C16	B20	C20	B25	C25	230VAC
	5	8	7	12	9	15	11	19	

Notes:

1. B20 and C20 is for GV6-100B024 and GV6-100B036 model.
2. B25 and C25 if for GV6-100B012.

GV6-100 series

100W Waterproof Constant Voltage LED Driver



OUTPUT SPECIFICATIONS

Parameter	Min.	Typ.	Max.	Notes
OUTPUT VOLTAGE TOLERANCE	-2% (-3% for GV6-150B012)	-	+2% (-3% for GV6-150B012)	-
TOTAL OUTPUT CURRENT RIPPLE (PK-PK)	-2% (-3% for GV6-150B012)	-	+2% (+3% for GV6-150B012)	Full load, measured by 20MHz bandwidth oscilloscope and the output paralleled a 0.1μF ceramic capacitor and 47μF electrolytic capacitor
TURN-ON VOLTAGE OVERSHOOT	-5%	-	+5%	220-240VAC, full load
LINE REGULATION	-0.5%	-	+0.5%	25°C ± 10°C ambient temperature, input voltage changes from 200VAC to 240VAC
LOAD REGULATION	-1%	-	+1%	25°C ± 10°C ambient temperature, 230 VAC input, load changes from 50% to 100%
TURN-ON DELAY TIME	-	0.5s	0.7s (1s for GV6-150B012)	230VAC, full load

GENERAL SPECIFICATIONS

Parameter	Min.	Typ.	Max.	Notes
EFFICIENCY AT 230VAC				
GV6-100B012	87% / 87% / 87%	89% / 89% / 89%	-	25°C ambient temperature, full load / 75% load / 50% load
GV6-100B024	87% / 86% / 85%	89% / 88% / 87%	-	
GV6-100B036	89% / 86% / 84%	90% / 88% / 86%	-	
DIELECTRIC STRENGTH	INPUT-OUTPUT	-	3750VAC	-
	INPUT-PE	-	1875VAC	-
	OUTPUT-PE	-	500VAC	-
GROUNDING RESISTANCE	-	-	0.1Ω	25A/60s, 25°C ± 10°C ambient temperature
INSULATION RESISTANCE	10MΩ	-	-	Input-Output, Input-PE, Output-PE, 500VDC/60s/25°C/70%RH
MTBF	-	200 000 hours	-	25°C ± 10°C ambient temperature, 230VAC, 80% load (MIL-HDBK-217F)
LIFETIME	-	50 000 hours	-	230VAC, 100% load, tc=75°C (refer to Lifetime Curve)
OPERATING CASE TEMPERATURE FOR SAFETY T _{C-S}	-40°C	-	+90°C	-
OPERATING CASE TEMPERATURE FOR SAFETY T _{C-W}	-40°C	-	+75°C	5 years warranty, humidity 10% to 100% RH
STORAGE TEMPERATURE	-40°C	-	+90°C	Humidity 10% to 100% RH
DIMENSIONS (L x W x H)	147.5x 67.2 x 37mm			-
NET WEIGHT	650 ± 50g			-
PACKAGE (L x W x H)	10pcs./box; 500 x 310 x 160 mm			-

GV6-100 series

100W Waterproof Constant Voltage LED Driver



SAFETY STANDARDS

SAFETY CATEGORY	COUNTRY / TERRITORY	STANDARDS
CE	Europe	EN61347-1
		EN61347-2-13

EMC STANDARDS

EMC CATEGORY	COUNTRY / TERRITORY	STANDARDS
CE	Europe	EN55015
		EN61000-3-2
		EN61000-3-3
		EN61547

Note: This LED driver meets the EMC specifications above, but EMC performance of luminaire that contains it depends also on the other devices connected to the driver and on the fixture itself.

PROTECTIONS

PARAMETER	Min.	Typ.	Max.	NOTES
INPUT UNDER VOLTAGE PROTECTION	150VAC	-	176VAC	Turn off the output when the input voltage falls below protection voltage.
OVER TEMPERATURE PROTECTION	Turn off the output. Returning to normal after over temperature is removed.			
SHORT CIRCUIT PROTECTION	Hiccup mode. The output shall return to normal when the fault condition is removed.			
OVER CURRENT PROTECTION	Hiccup mode. The output shall return to normal when the fault condition is removed.			
OVER VOLTAGE PROTECTION	Turn off the output voltage, when the fault is removed, restart and resume.			

GV6-100 series

100W Waterproof Constant Voltage LED Driver



MECHANICAL SPECIFICATION

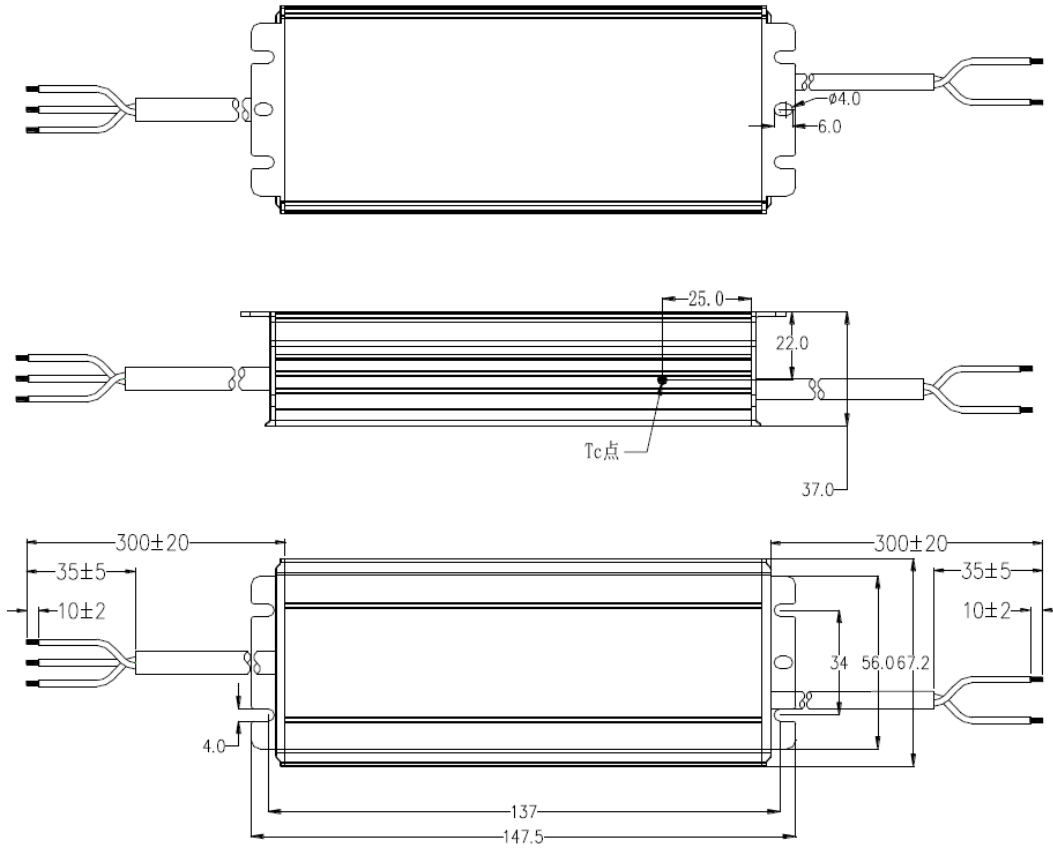

Wire	Specification	Note
INPUT	CCC + VDE, 3x1.0mm ² , length = 300 ± 20mm, peel-length = 35 ± 5mm, Tin-Dip length = 10 ± 2mm	For CCC/CE
	AC/L: brown, AC/N: blue, FG: green/yellow	
OUTPUT	12V: CCC + VDE, 2x1.5mm ² , length = 300 ± 20mm, peel-length = 35 ± 5mm, Tin-Dip length = 10 ± 24mm	For CCC/CE
	24V: CCC + VDE, 2x1.0mm ² , length = 300 ± 20mm, peel-length = 35 ± 5mm, Tin-Dip length = 10 ± 24mm	
	V _{o+} : brown, V _{o-} : blue	

CHARACTERISTICS

INRUSH CURRENT WAVEFORM

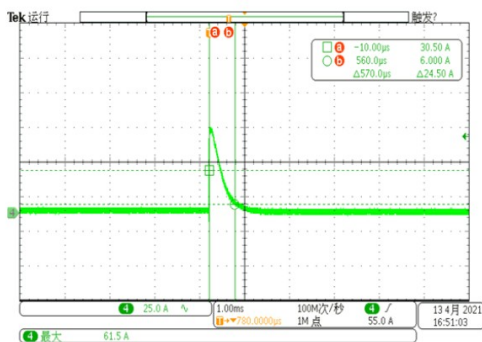

OUTPUT POWER vs. INPUT VOLTAGE CURVE

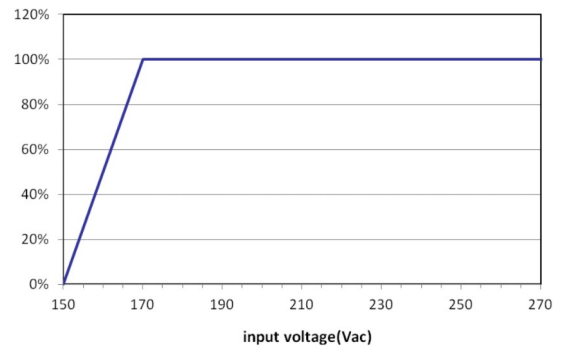

GV6-100 series

100W Waterproof Constant Voltage LED Driver



LIFETIME vs. CASE TEMPERATURE CURVE

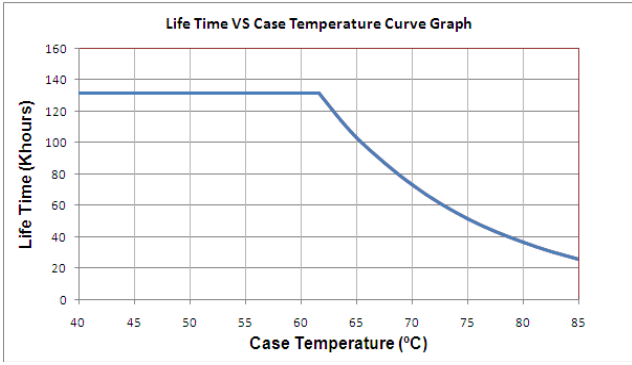

DERATING CURVE

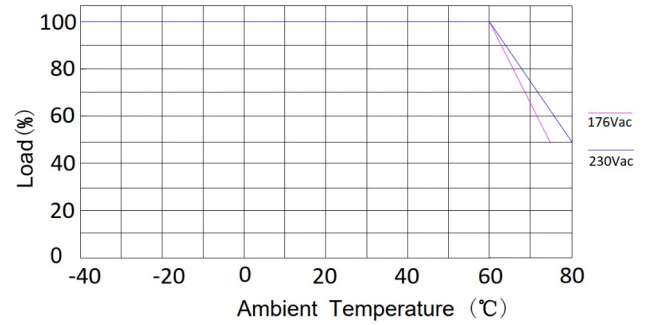

POWER FACTOR vs. LOAD CURVE

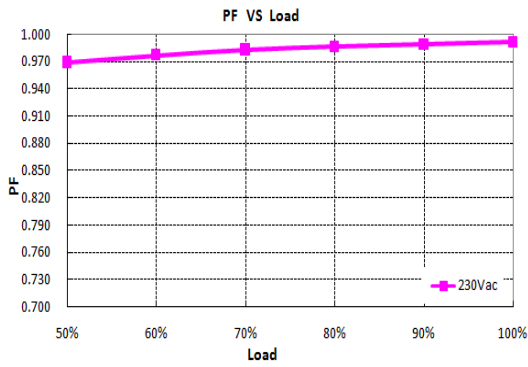

THD vs. LOAD CURVE

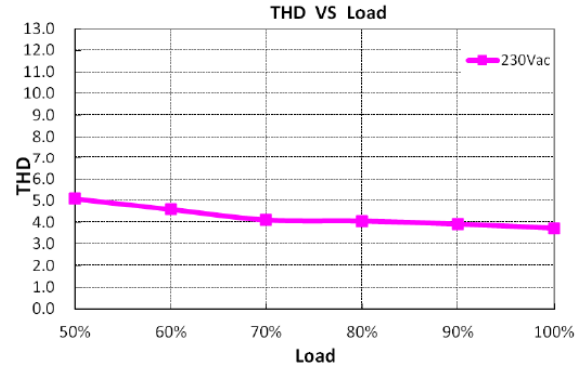

EFFICIENCY vs. LOAD CURVE

GV6-100B012

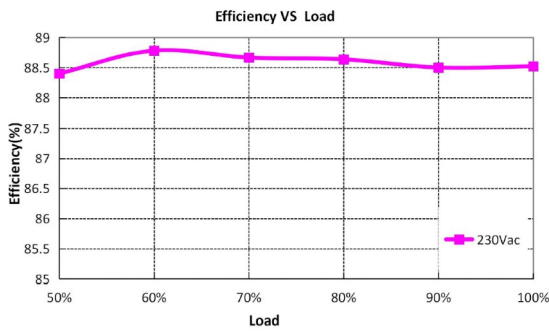

GV6-100B024

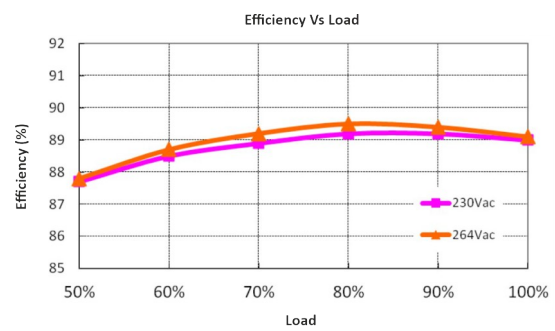

GV6-100B036

